

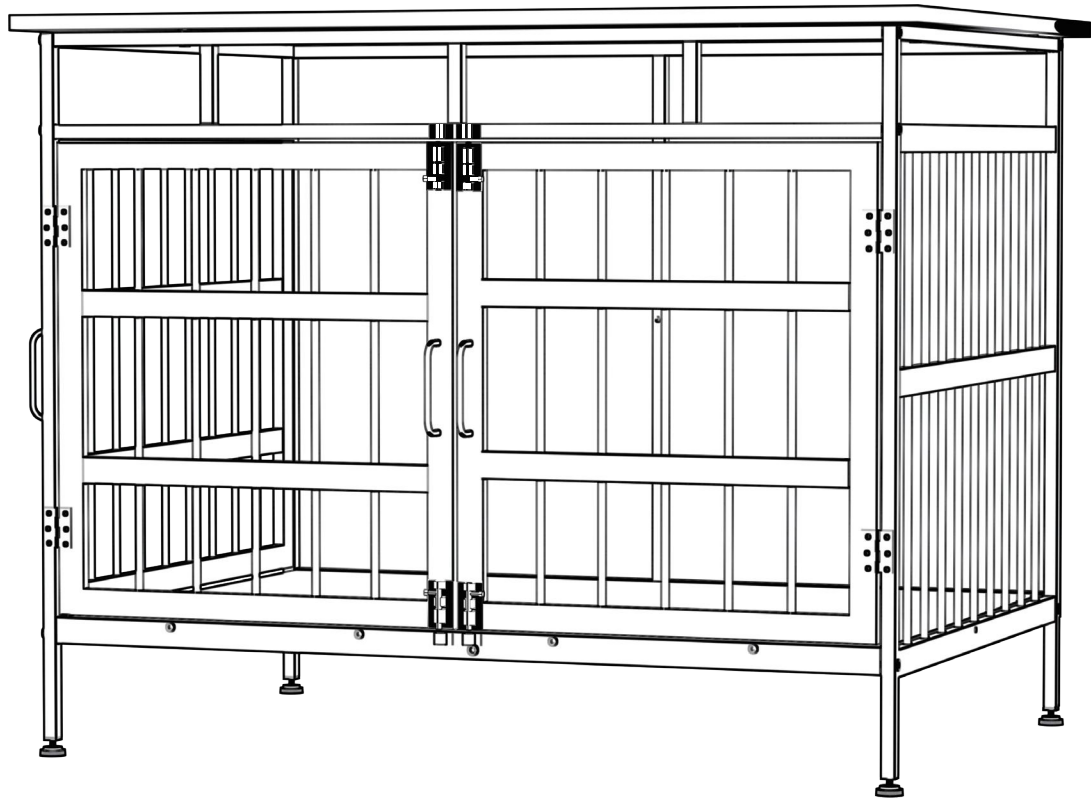

Dog Crate Furniture

Heavy Duty Dog Kennel



L

User Manual

Model:DC-01

WARRANTY & CUSTOMER SERVICE

We offer a 100% satisfaction guarantee and 12 months warranty! If you have any questions about this product, please feel free to contact us at support@ilinvivon.com

24 Hours Customer Support: Linvivon Customer Service Team

Mail: support@ilinvivon.com

MADE IN CHINA

CAUTION

IMPORTANT: Please read carefully before assembly.

1. Be sure to check all packaging materials, as small parts may loosen from the carton during transportation.
2. Take out all the accessories from the plastic bag and classify them according to similar items.
3. Please keep children and animals away from the installation area to prevent them from swallowing small parts.
4. Before assembling, make sure you have enough space to place all the parts.
5. Assemble the product as accurately as possible and close to its final position (in the same room).
6. Always use appropriate tools.
7. Follow the assembly steps in sequence and do not skip any steps.
8. Regularly check to ensure that all connectors are securely fastened.
9. During installation, do not stand on top of the product as it may cause damage.
10. Do not place dog crate directly in front of heating equipment, fire sources, or any other heating objects.
11. Please keep these instructions for future reference.

12. If there are two people, the assembly work will be easier.
13. Please handle all packaging materials properly and responsibly.
14. To reduce the possibility of product damage and guarantee personal safety, please ensure that the electric drill is set to low torque installation.

Warning:

1. Children are prohibited from climbing dog crate furniture.
2. Our team is not responsible for any damage or injury caused by failure to follow assembly instructions correctly, failure to assemble products correctly, or failure to use products correctly.

Warm Tips

Upon first use, please refer to the user manual, or scan the QR code to watch the installation guide video for specific operations.



Thank you for choosing Linvivon !

If you have any problems, please contact us at support@ilinvivon.com immediately.

Linvivon customer service team is committed to providing you with the fastest and most effective solutions.

PRODUCT SPECIFICATION

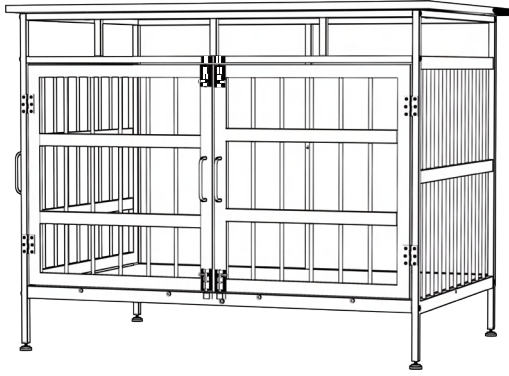

Product name	Dog Crate Furniture
Model	DC-01
Material	Particle Board + Iron
Product Size	
S	29"L * 21"W * 27"H
N.W.	15.6kg

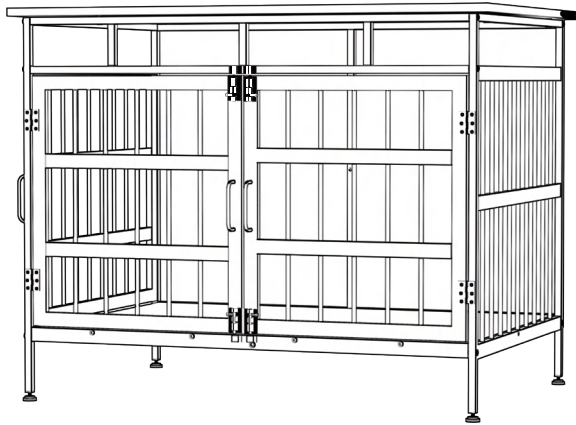



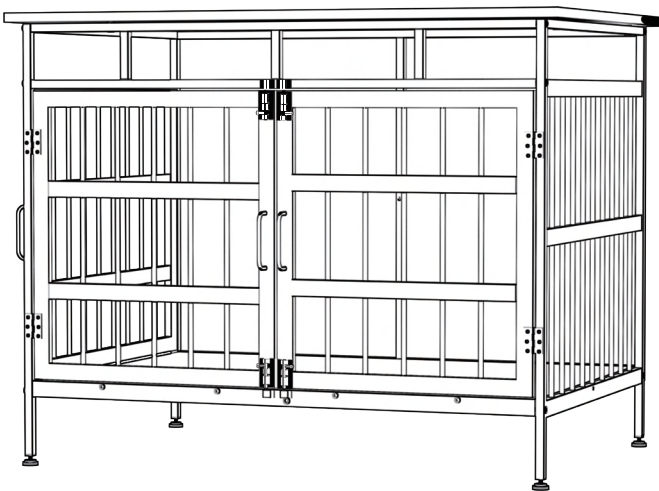



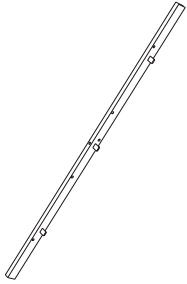
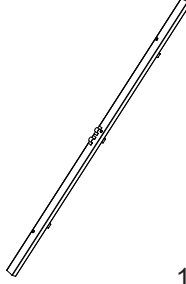

Product name	Dog Crate Furniture
Model	DC-01
Material	Particle Board + Iron
Product Size	
M	39"L * 27.5"W * 32"H
N.W.	23.4kg

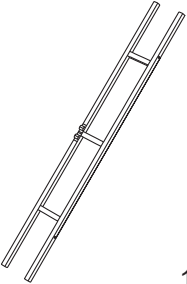
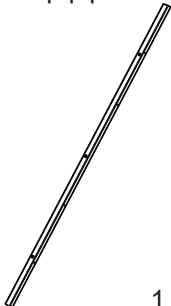
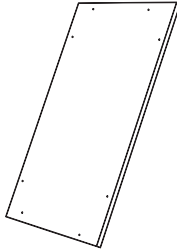
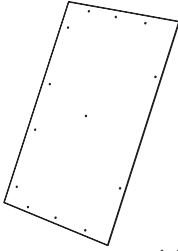
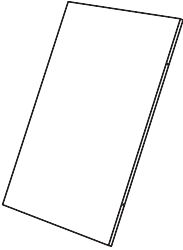
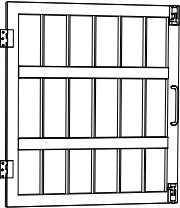
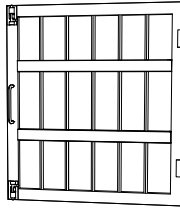
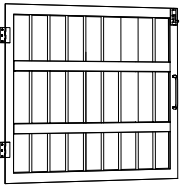
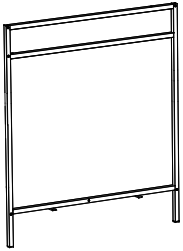
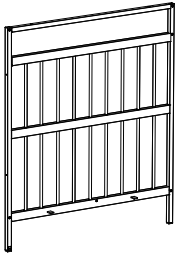
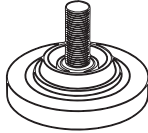
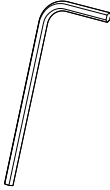
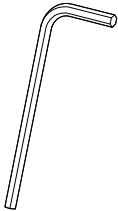
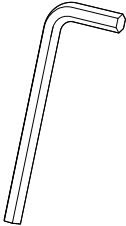

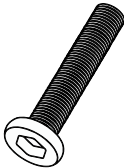
Product name	Dog Crate Furniture
Model	DC-01
Material	Particle Board + Iron
Product Size	
L	47"L * 30"W * 35.5"H
N.W.	31kg

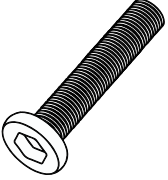
PACKING LIST

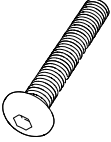
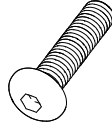
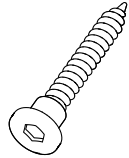
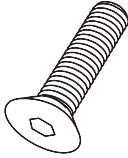
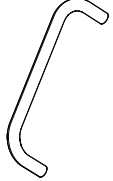
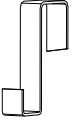
<p>A Bottom middle pipe</p>  <p>1 PCS</p>	<p>B Rear bottom pipe</p>  <p>1 PCS</p>	<p>C Front bottom pipe</p>  <p>1 PCS</p>	<p>D Rear vertical pipe</p>  <p>1 PCS</p>
<p>E Front top pipe</p>  <p>1 PCS</p>	<p>F Rear top pipe</p>  <p>1 PCS</p>	<p>G Top board</p>  <p>1 PCS</p>	<p>H Back board</p>  <p>1 PCS</p>
<p>I Bottom board</p>  <p>1 PCS</p>	<p>J Left front door</p>  <p>1 PCS</p>	<p>K Right front door</p>  <p>1 PCS</p>	<p>L Side door (left)</p>  <p>1 PCS</p>
<p>M Left frame</p>  <p>1 PCS</p>	<p>N Right frame</p>  <p>1 PCS</p>	<p>O Foot pad</p>  <p>4 PCS</p>	<p>P Allen key (M4)</p>  <p>1+1 PCS</p>
<p>Q Allen key (M5)</p>  <p>1 PCS</p>	<p>R Allen key (M6)</p>  <p>1 PCS</p>	<p>S M6*25 screw</p>  <p>8+2 PCS</p>	<p>T M6*30 screw</p>  <p>11+2 PCS</p>

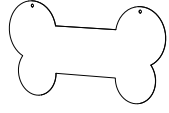
U M6×40 screw  1+1 PCS	V M4*8 screw  18+2 PCS	W M4*20 screw  6+2 PCS	X M5*10 screw  13+2 PCS	Y M6 wood screw  6+2 PCS
Z M6*30 flat screw  2+1 PCS	AA Handle  3 PCS	AB Couple  1 PCS	AC Chain  1 PCS	AD DIY Nameplate  1 PCS

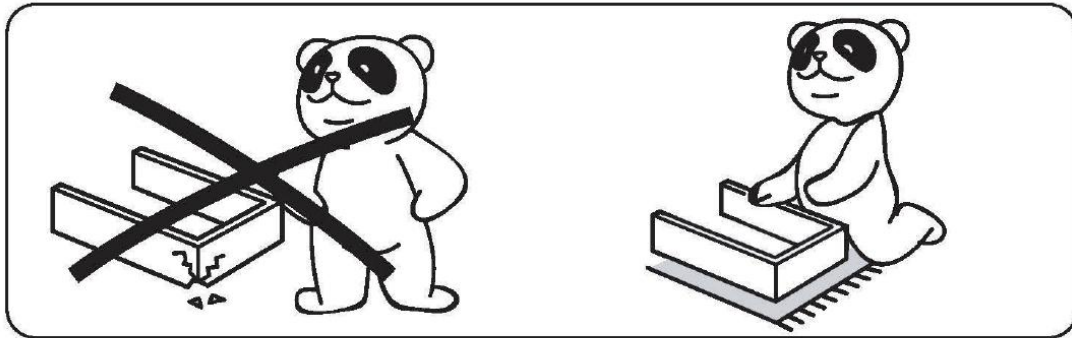
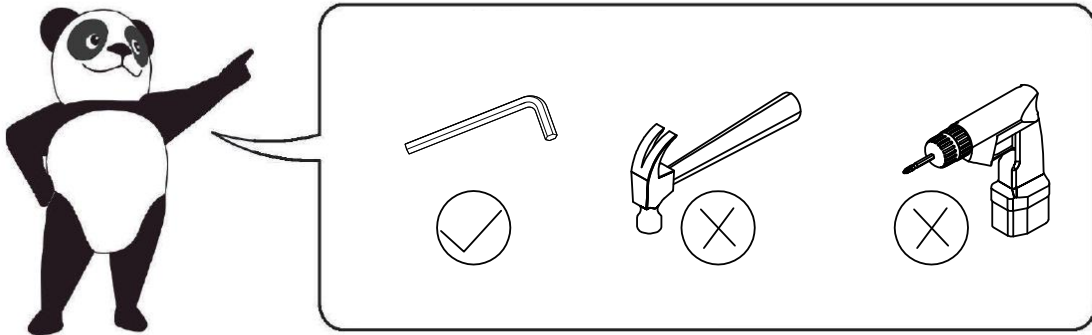

Assemble dog crate on empty carton, carpet, or rug to prevent scratch or damage.

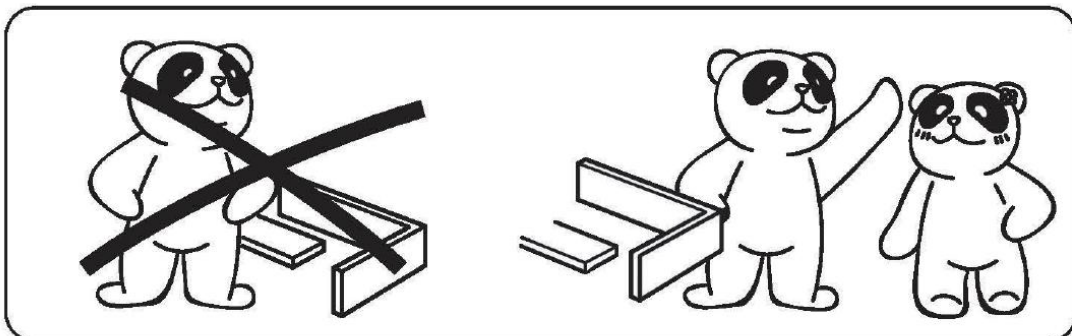

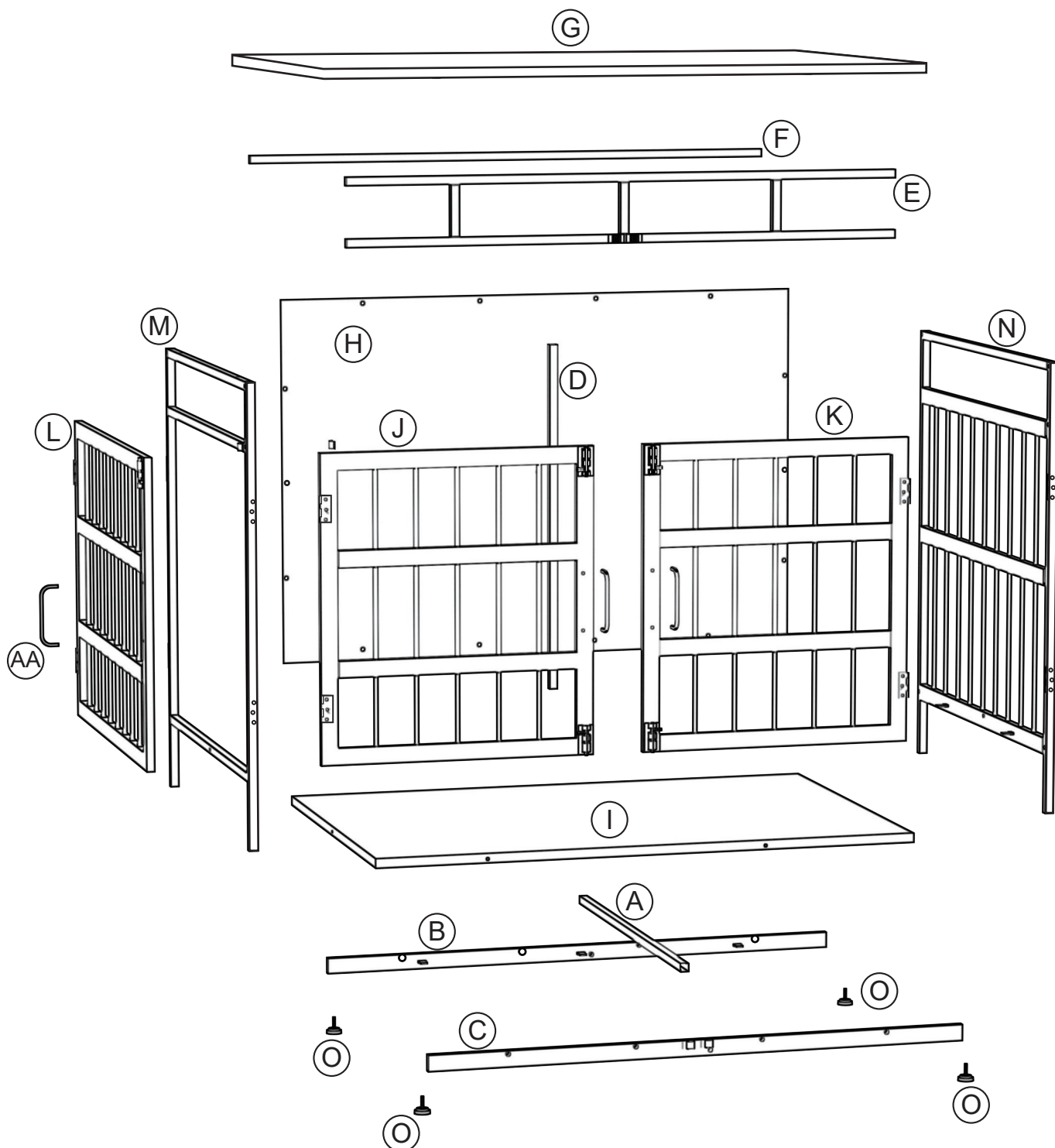

Recommended 2-person assembly. Make sure no parts are missing or damaged before assembly.



INSTALLATION STEPS

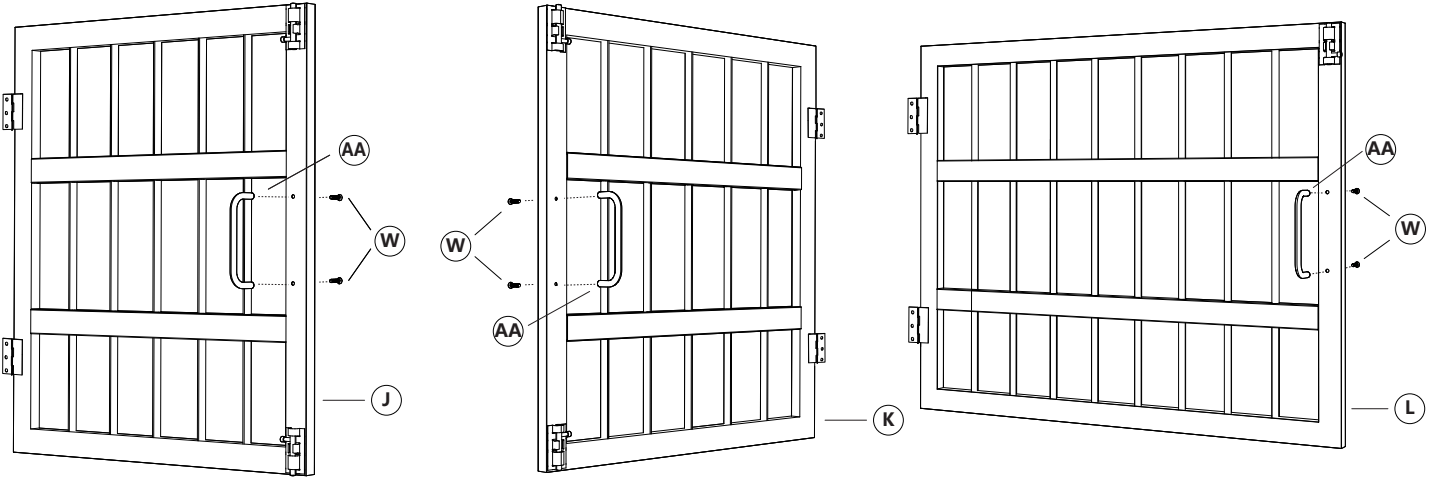

Install (J) door frame, use (W) to fix (AA)
 Install (K) door frame, use (W) to fix (AA)
 Install (L) door frame, use (W) to fix (AA)

	W*6pcs
	P*1pcs
	AA*3pcs



Step 1

Pay attention to identifying the pipe (B) direction. Ensure the middle hole is on the right side of the gasket, and align it with the pipe (C) hole.



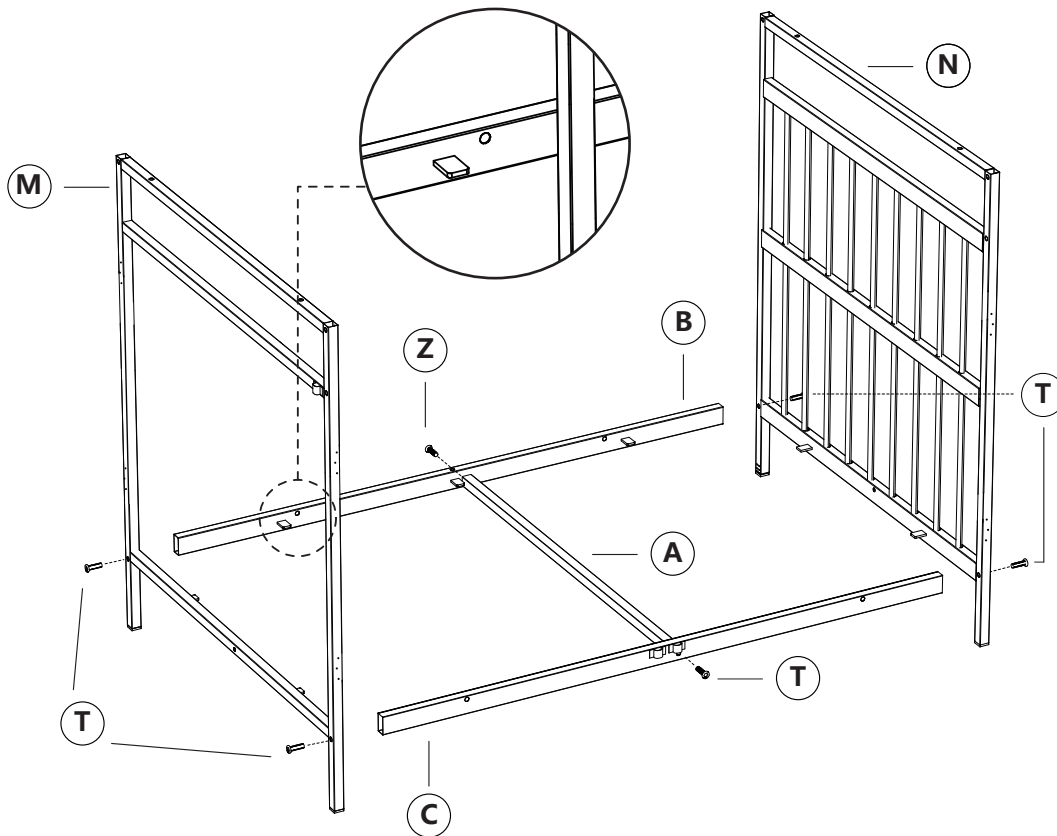

	T*5pcs
	Z*1pcs
	R*1pcs



Step 2

Quick Installation Tips:

1. The side of pipe (D) with holes faces the back.
2. The side of pipe (F) with holes faces upward.

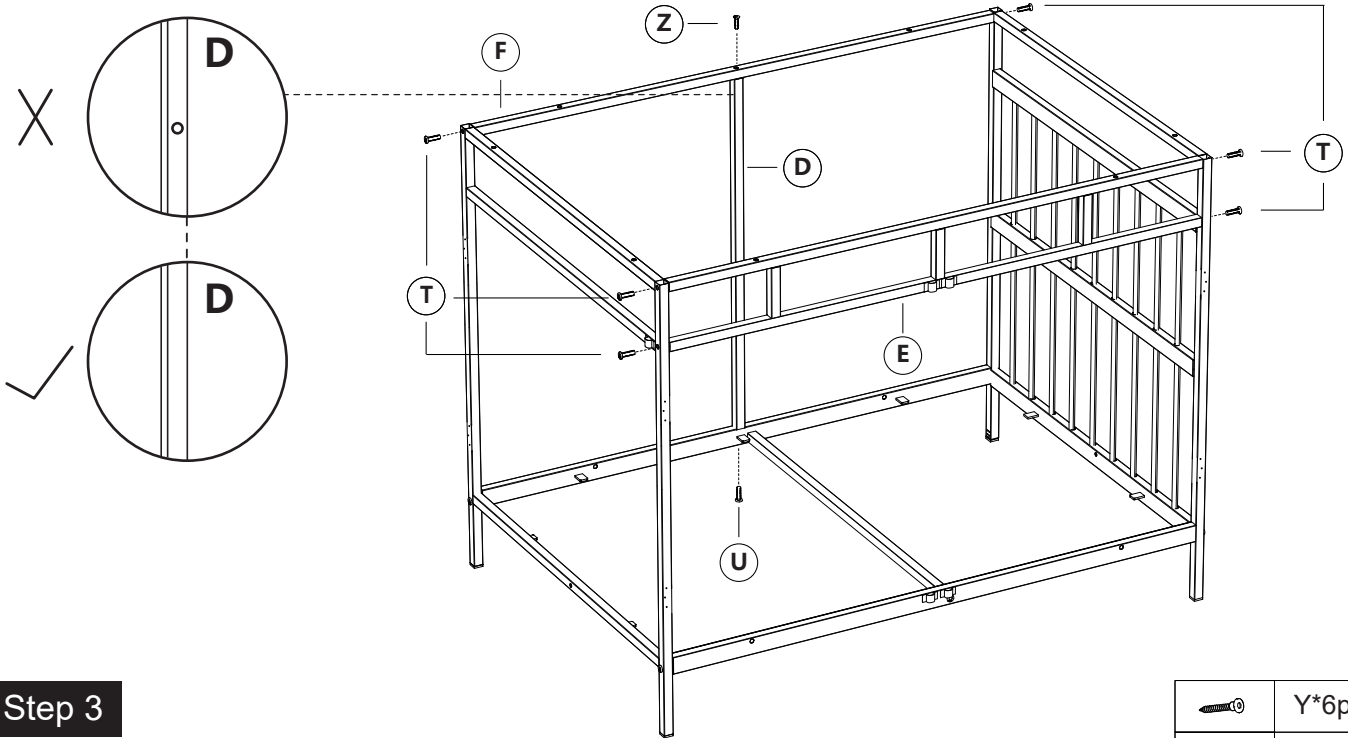

	T*6pcs
	Z*1pcs
	U*1pcs
	R*1pcs



Step 3

Quick Installation Tips:

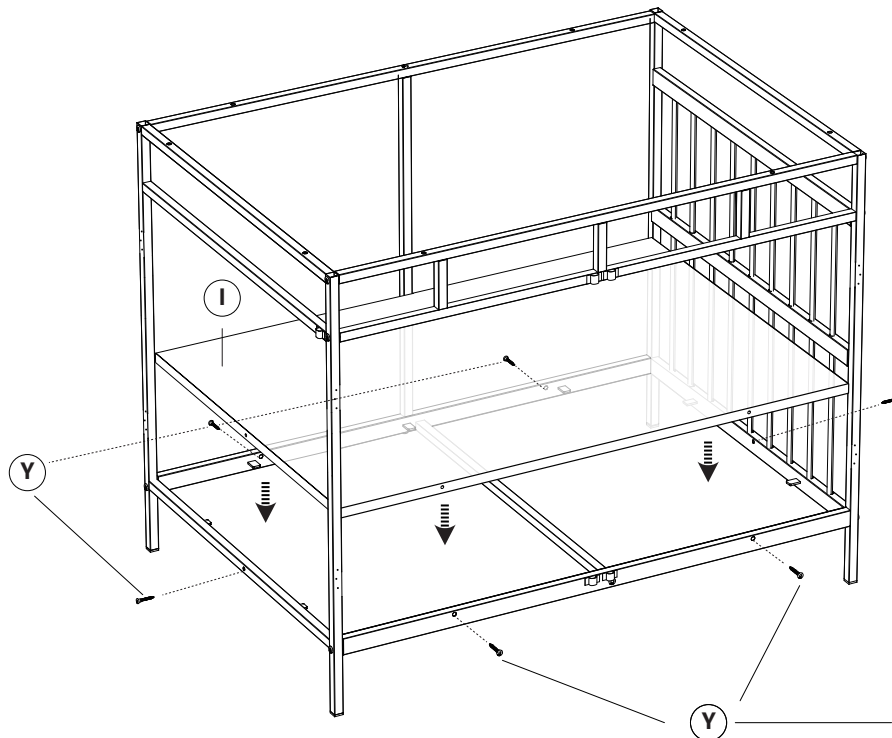

1. Mind Your Hand.
2. Pay attention to distinguish the up and down direction of the bottom plate, and ensure that the holes are aligned before installation.

	Y*6pcs
	R*1pcs

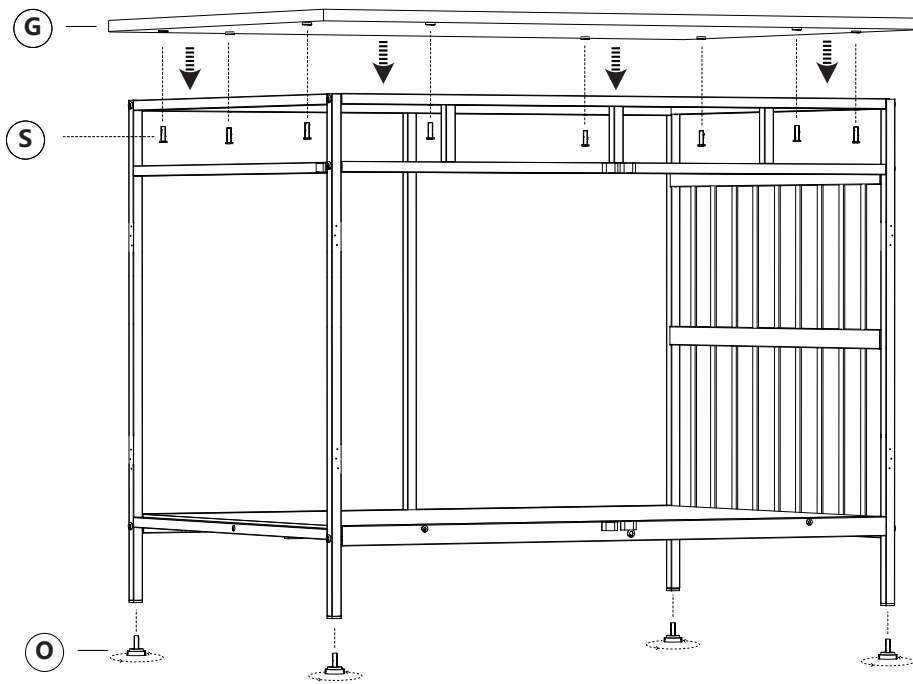

Step 4





	S*8pcs
	R*1pcs
	O*4pcs

Step 5

Install the back side.



Quick Installation Tips:

Suggest installing it upside down, please align the holes and prioritize positioning the middle screw.

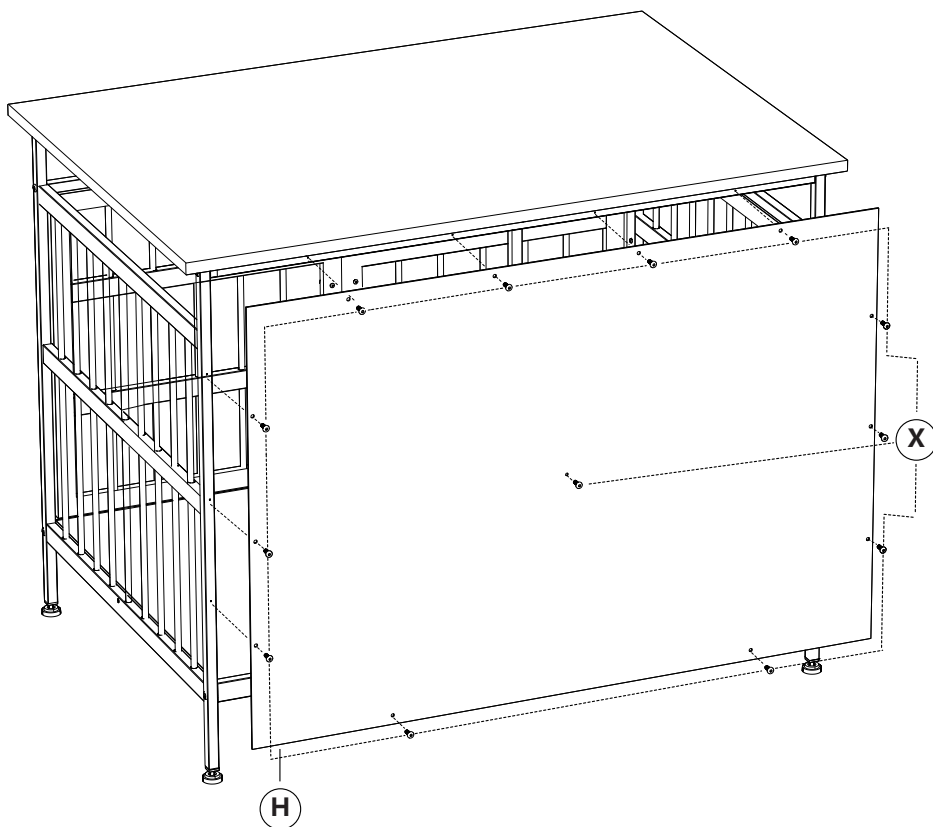
	X*13pcs
	Q*1pcs



Step 6

	V*18pcs
	P*1pcs

Quick Installation Tips:

1. Grasp door and upper edge of the door frame by hand to fix door position for better installation.
2. First secure the 2 middle screws of the upper and lower hinges.

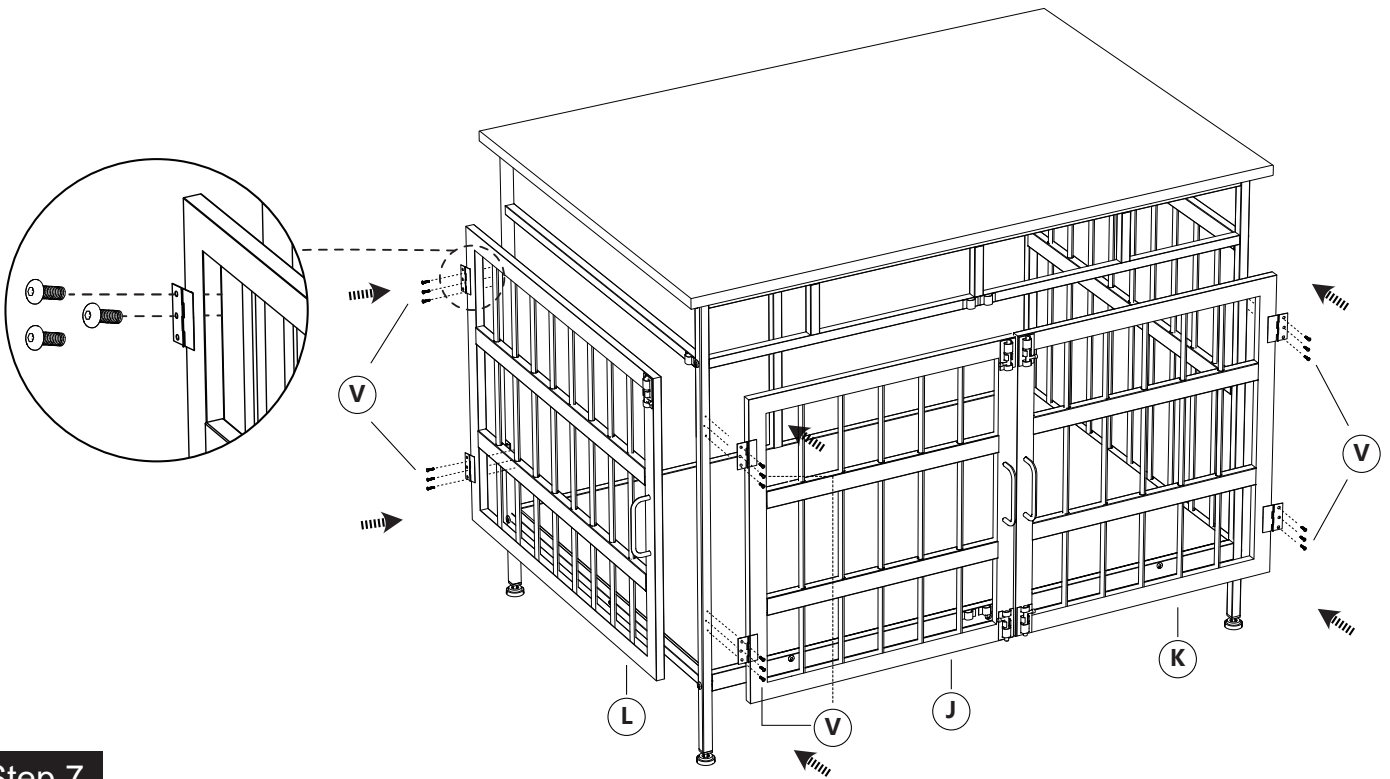

Step 7

Complete installation.

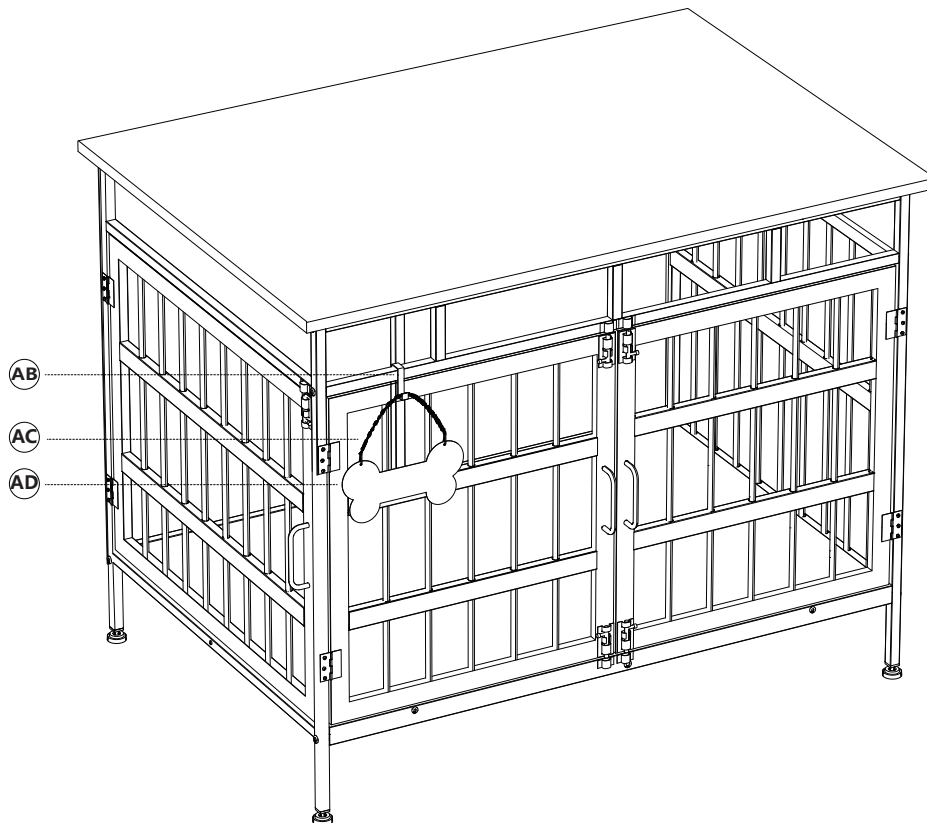

CLEAN & MAINTENANCE

1. Please clean with a damp cloth or mild detergent. Do not use bleach or abrasive cleaners.
2. Please regularly check the product for missing or loose screws.
3. Do not lean on products containing the following ingredients: acetone (eg. nail polish remover), ammonia (eg. bleach) or sodium hydroxide (eg. caustic soda, sewage and oven cleaner).
4. If the product accidentally comes into contact with irritating liquids, please rinse thoroughly with clean water.
5. This product should not be disposed of together with household waste. Please send it to the local waste disposal center.



Prevent Collapse



No Climbing



No Dragging



Anti-electric Shock